









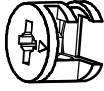
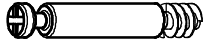

 Ø6,3x50 mm <b>A1 x 44</b>	 Ø12 mm <b>A2 x 44</b>	 4 mm <b>A3 x 1</b>	 Ø15x12 mm <b>B1 x 12</b>	 Ø5x44 mm <b>B2 x 12</b>
 Ø20 mm <b>B3 x 12</b>	 Ø12x3 mm <b>C x 5</b>	 Ø3x16 mm <b>D1 x 16</b>	 Ø4x16 mm <b>D2 x 48</b>	 Ø4x20 mm <b>D3 x 5</b>
 Ø4,2x32 mm <b>D4 x 10</b>	 Ø1,6x20 mm <b>F x 238</b>	 Ø8x36 mm <b>G x 23</b>	 <b>H x 5</b>	 <b>I x 2</b>
 <b>K x 2</b>	 Ø5x16 mm <b>L x 14</b>	 <b>M1 x 6</b>	 <b>M2 x 3</b>	
 Ø15 mm <b>N x 8</b>	 774 mm <b>O1 x 1</b>	 420 mm <b>O2 x 1</b>	 942 mm <b>P x 1</b>	

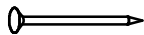

### Box 1 / 3

1498x498x16 mm

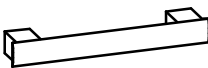
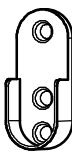
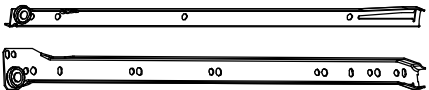

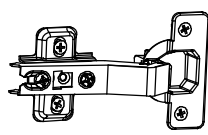
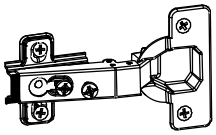
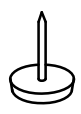
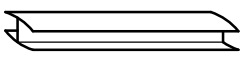
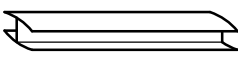
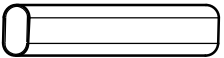
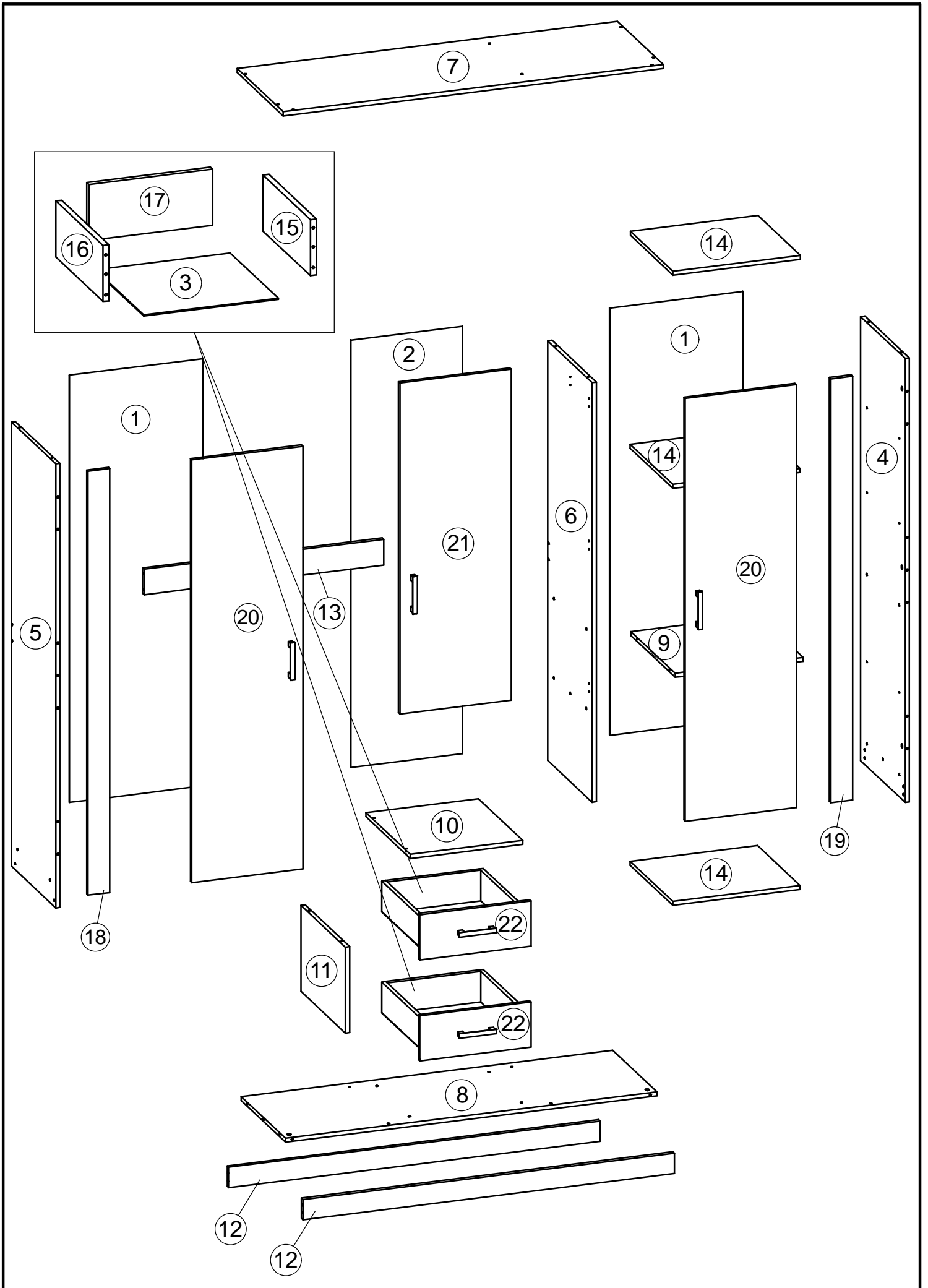
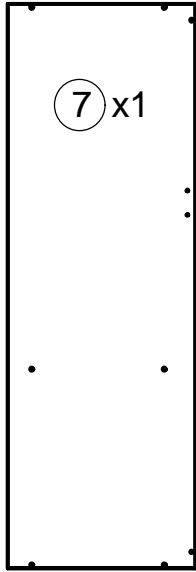
1464x480x16 mm

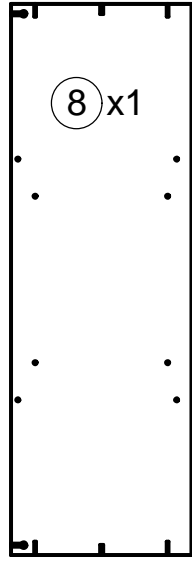

503x480x16 mm

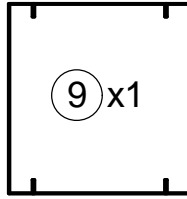

339x480x16 mm

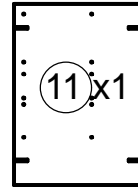

80x1464x16 mm

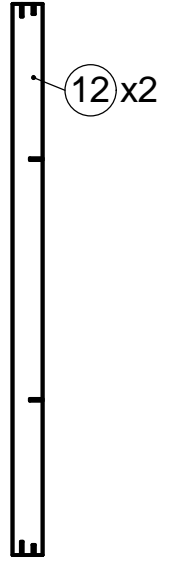

442x480x16 mm

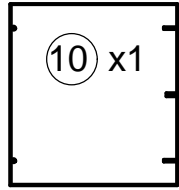

502x460x16 mm

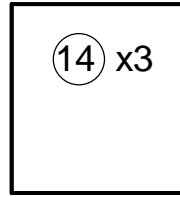

100x945x16 mm

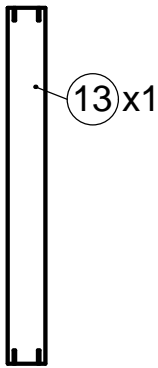

450x120x16 mm

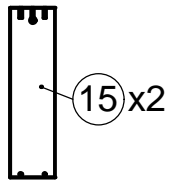

450x120x16 mm

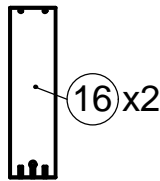

368x120x16 mm

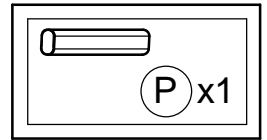
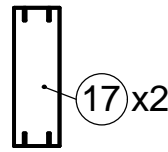

Fittings & Tools

### Box 2 / 3

1750x480x16 mm

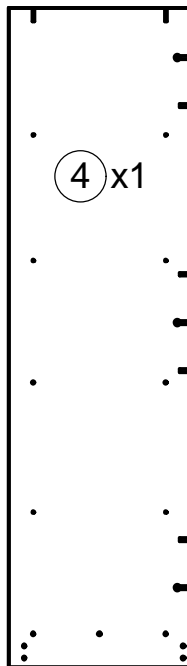

1750x480x16 mm

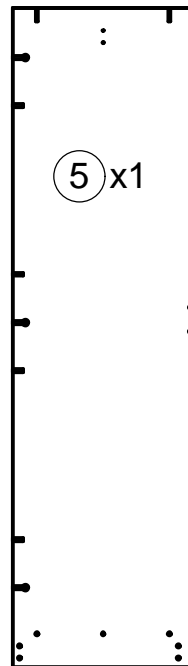

1654x480x16 mm

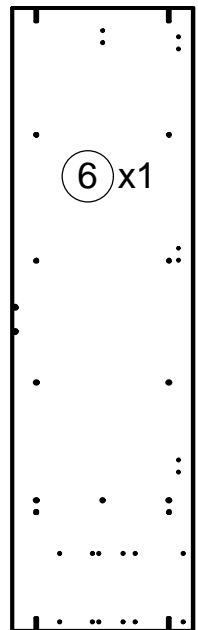

**Box 3 / 3**

1684x525x3 mm

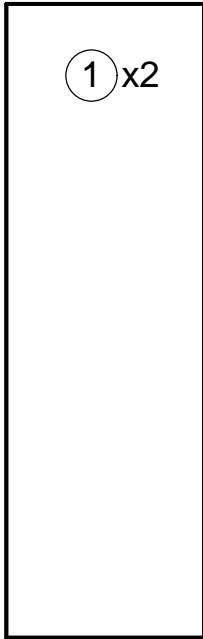

456x398x3 mm

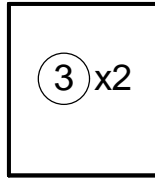

1684x441x3 mm

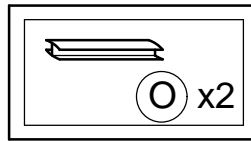
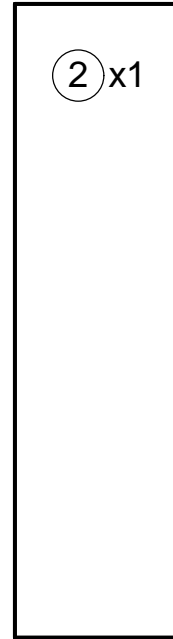

1670x85x16 mm

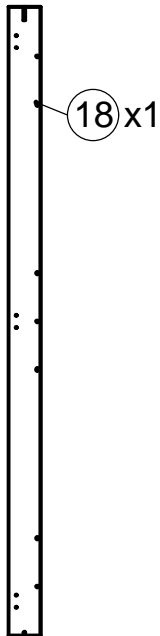

1670x85x16 mm

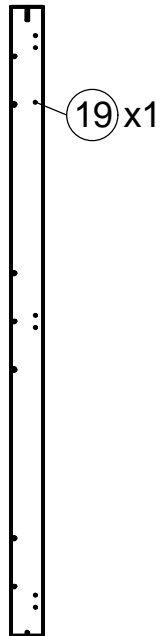

1665x437x16 mm

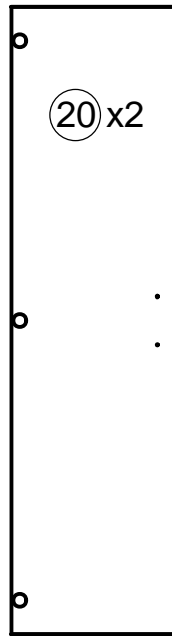

1303x437x16 mm

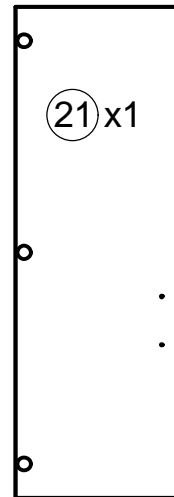

437x177x16 mm

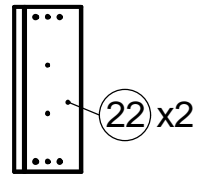

1

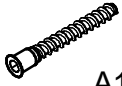

A1 x 4



A2 x 4



A3 x 1



B1 x 2

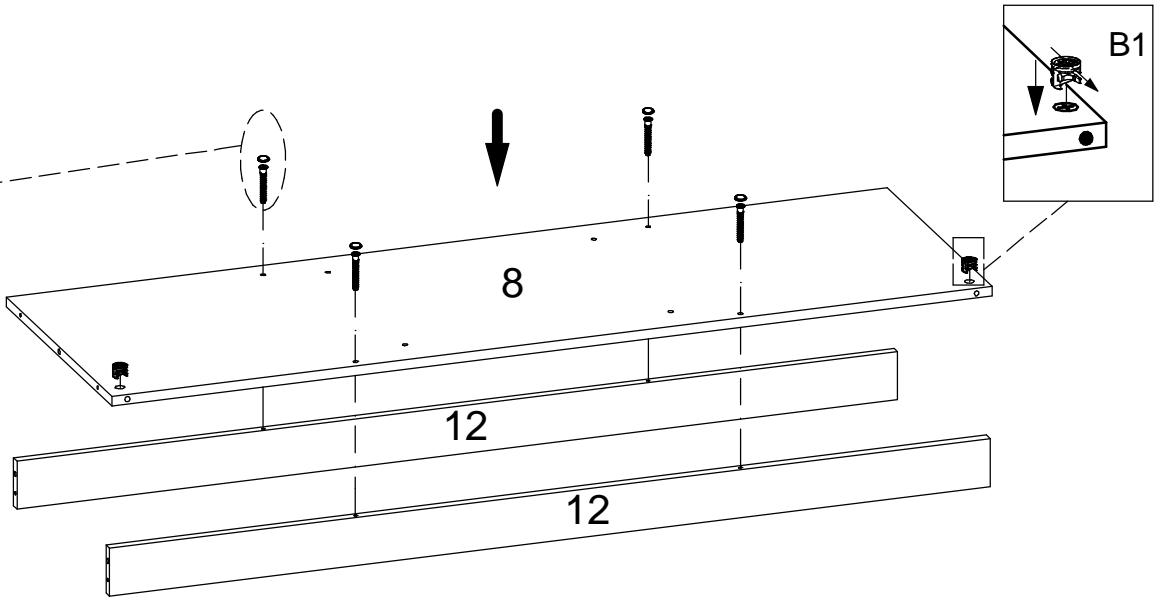
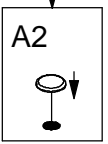
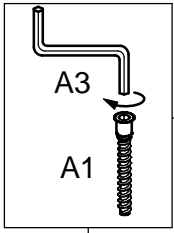

2

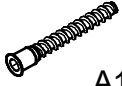

A1 x 2



A2 x 2



A3 x 1

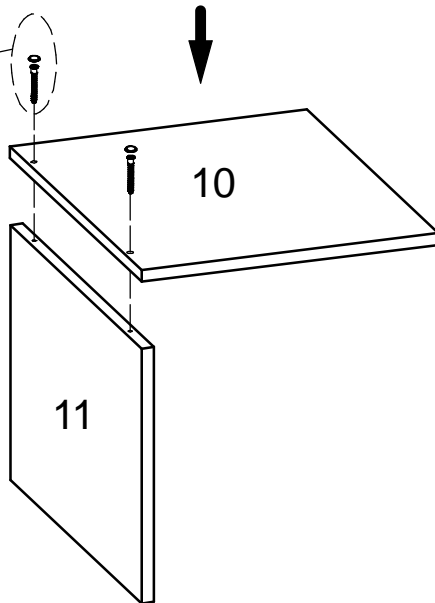
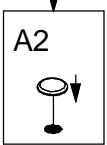
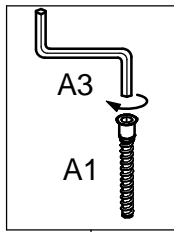
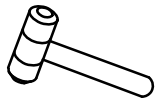

3

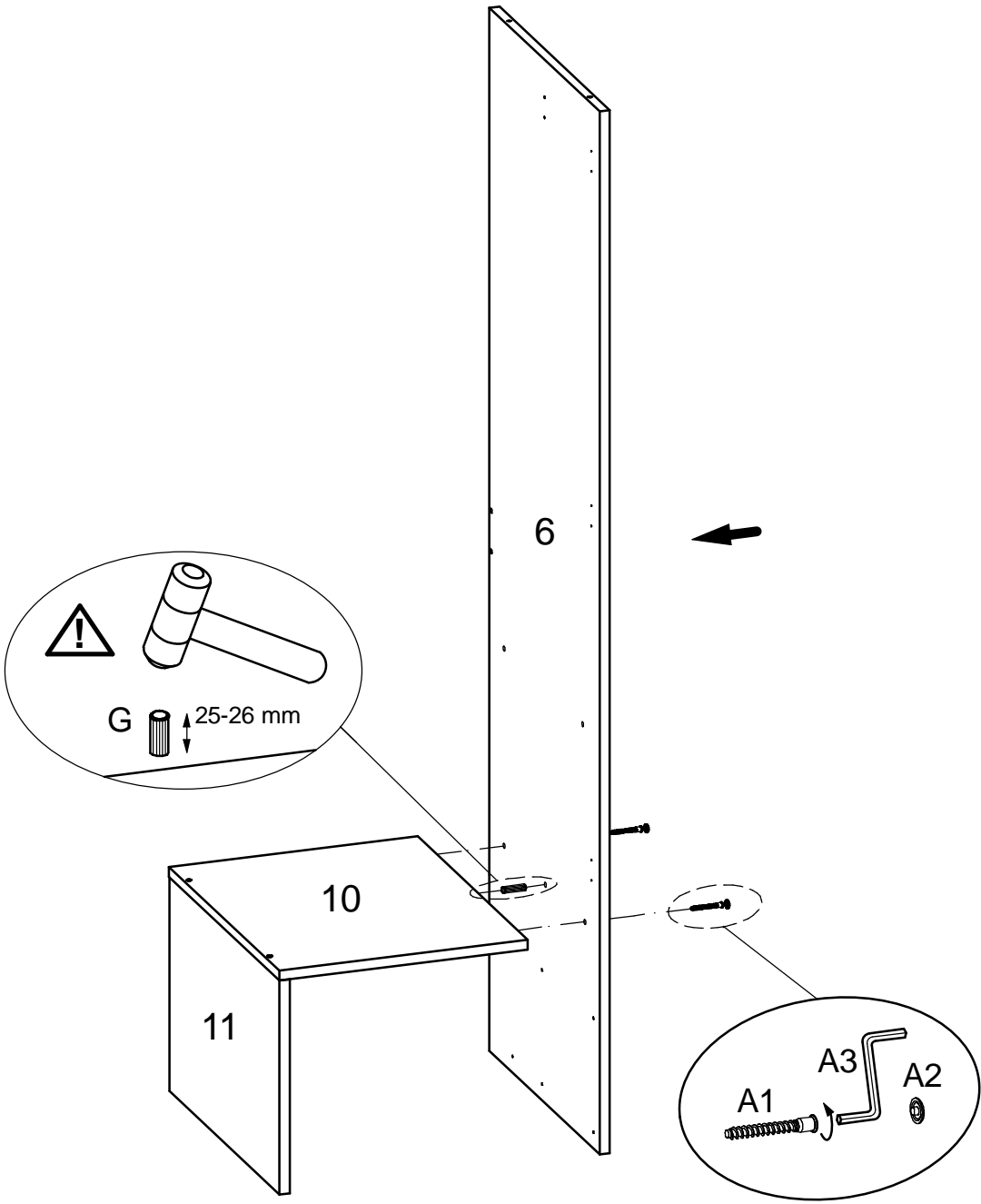
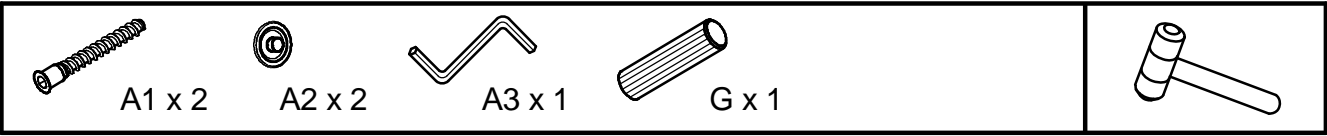



4

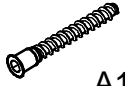

A1 x 4



A2 x 4



A3 x 1

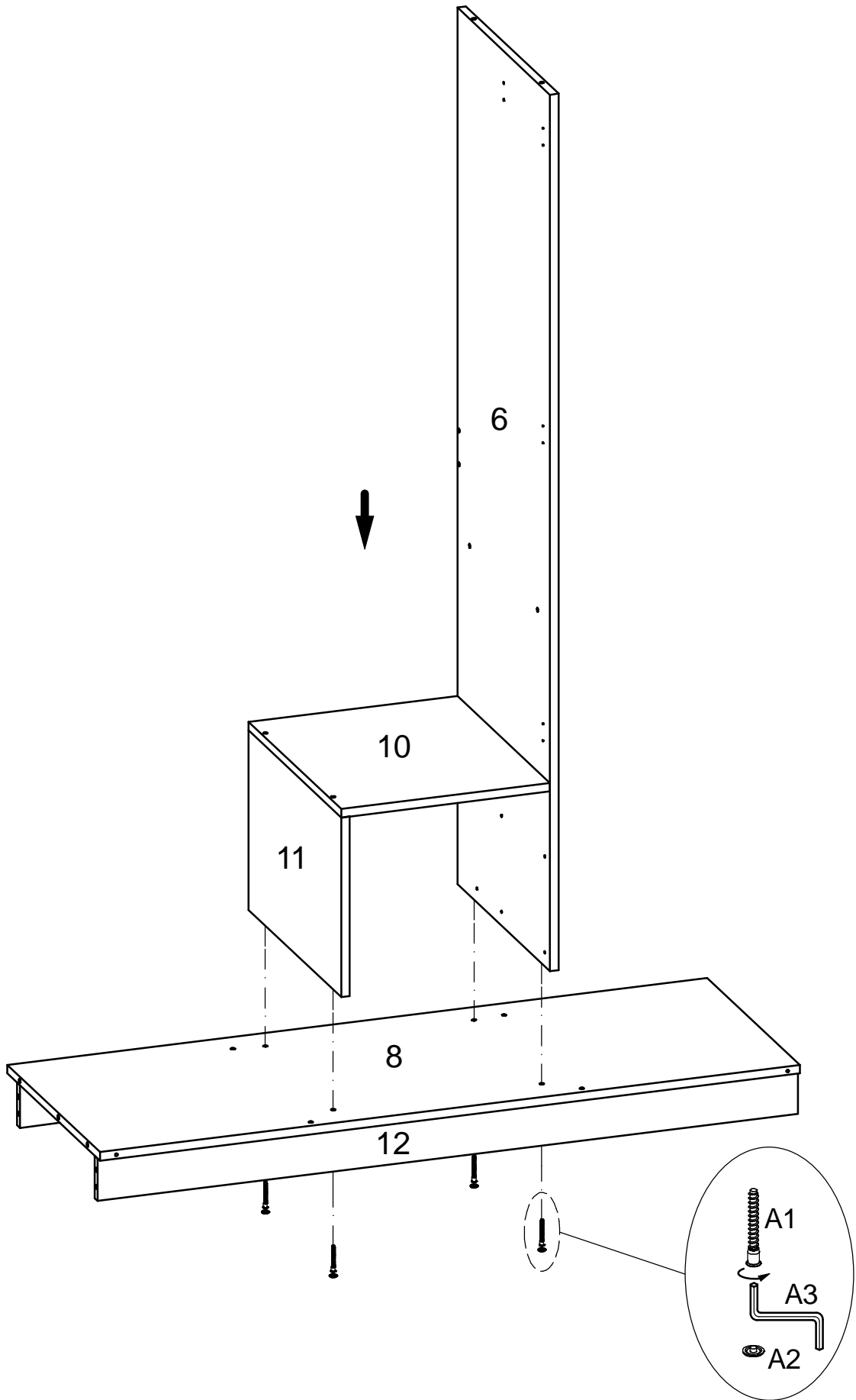
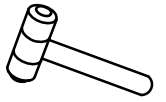

5



A1 x 16



A2 x 16

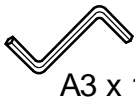

A3 x 1



D1 x 4

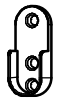

I x 2

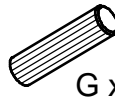

G x 6

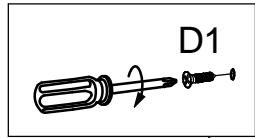
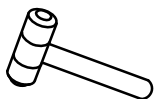
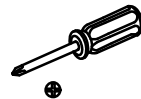

D1

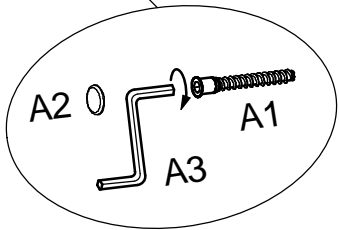
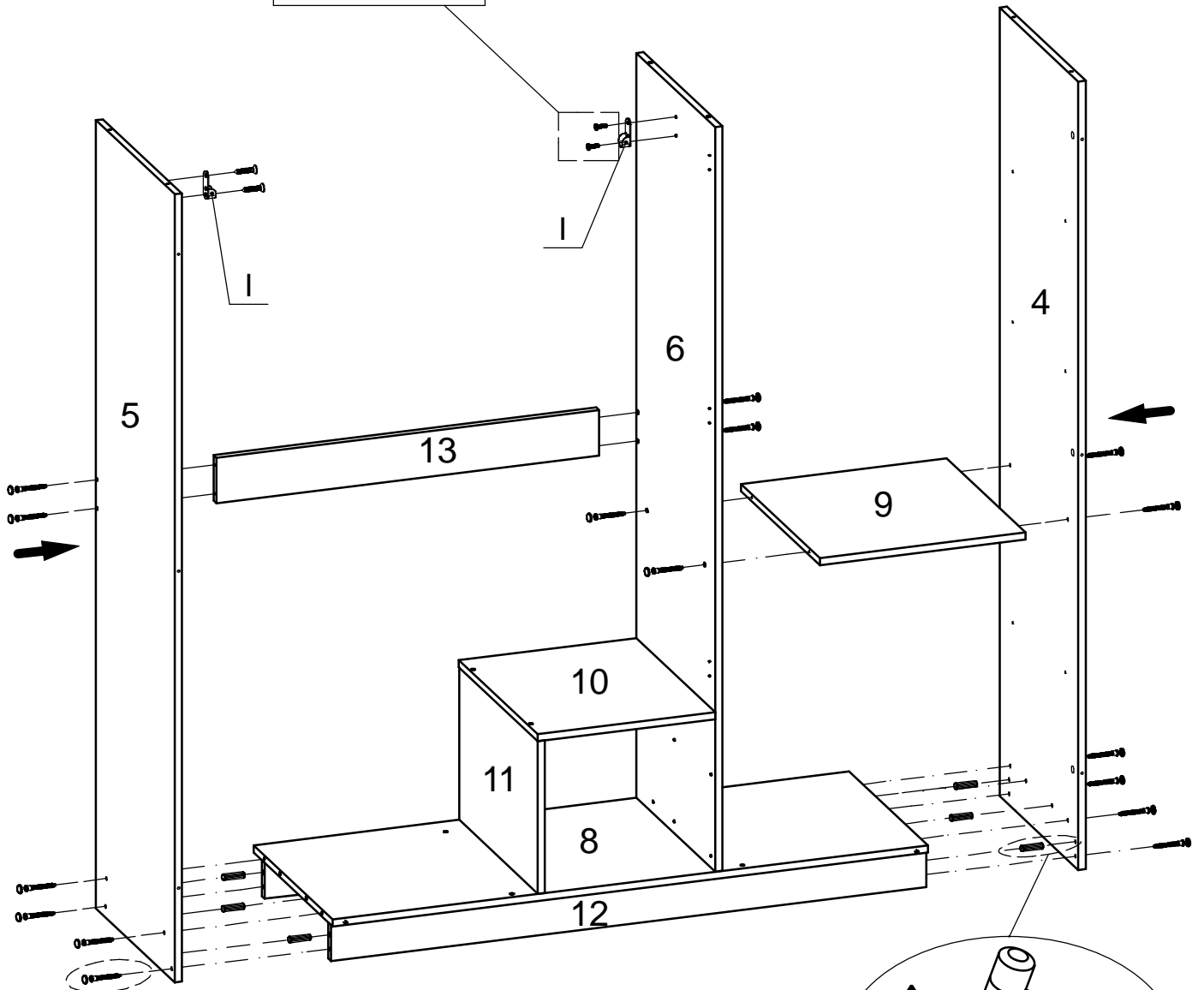

A2

A1

A3

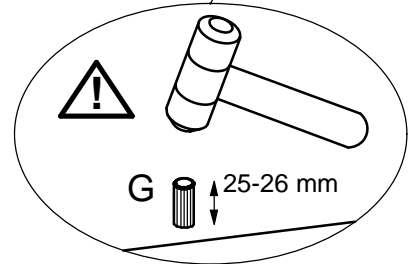

G

25-26 mm

6

  
D2 x 12

  
M1.1 x 6

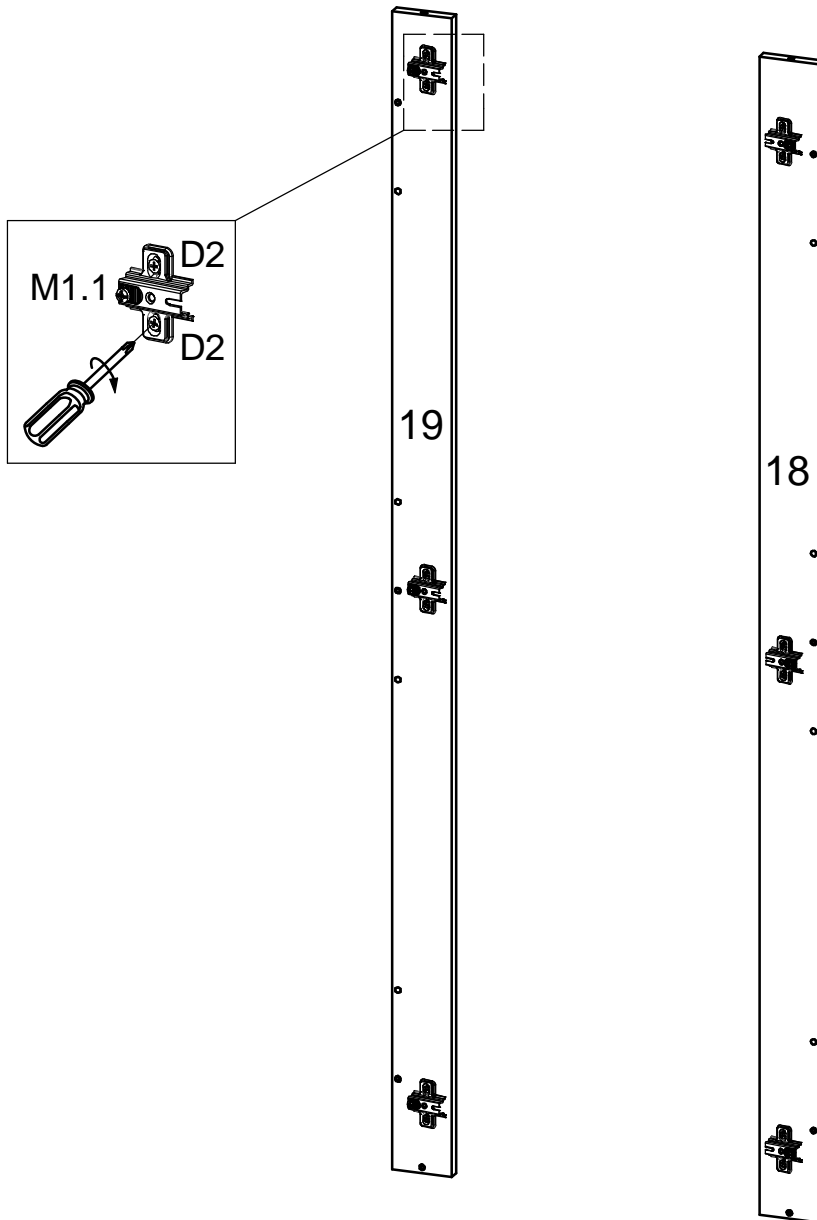
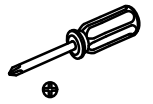

7



B1 x 6



B2 x 8



B3 x 8



G x 8



L x 12

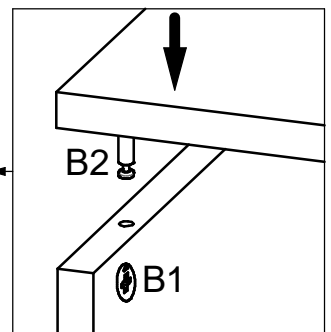
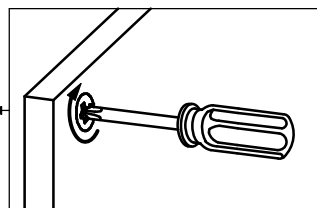
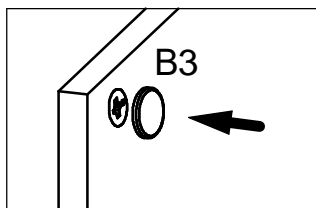
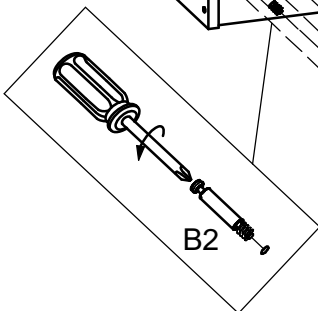
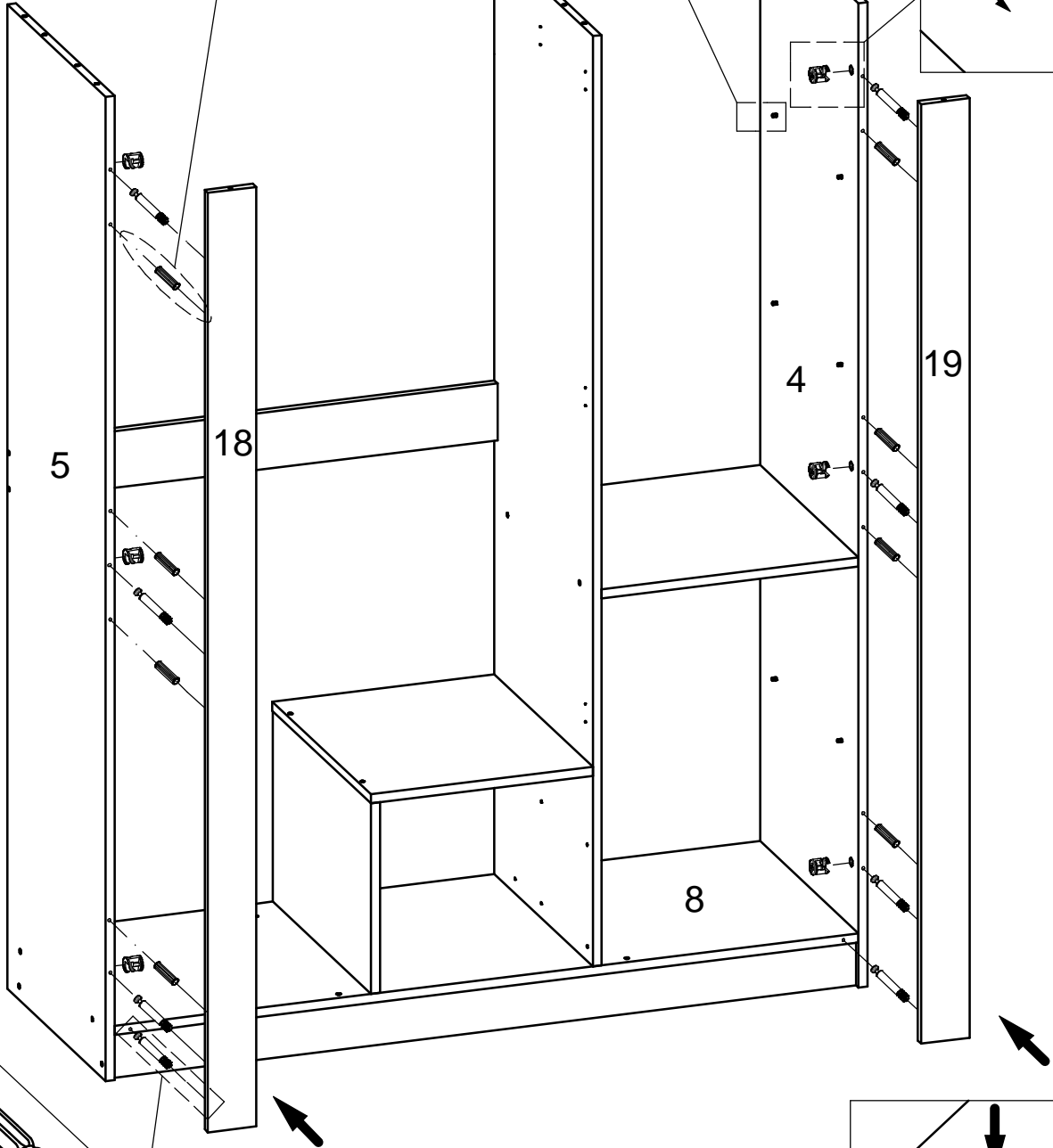
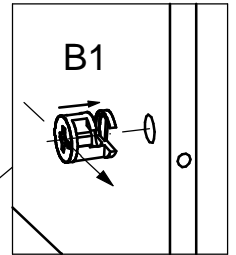
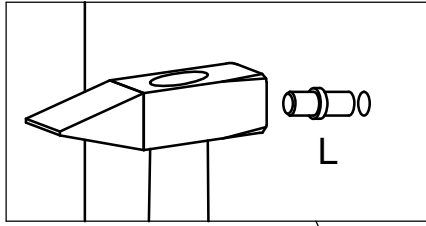
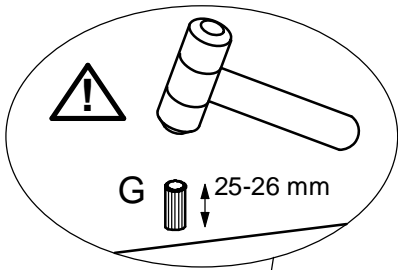
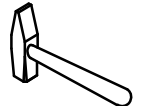
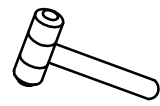
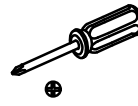

8

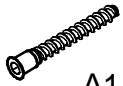

A1 x 8



A2 x 8



A3 x 1



L x 2

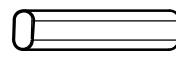

P x 1

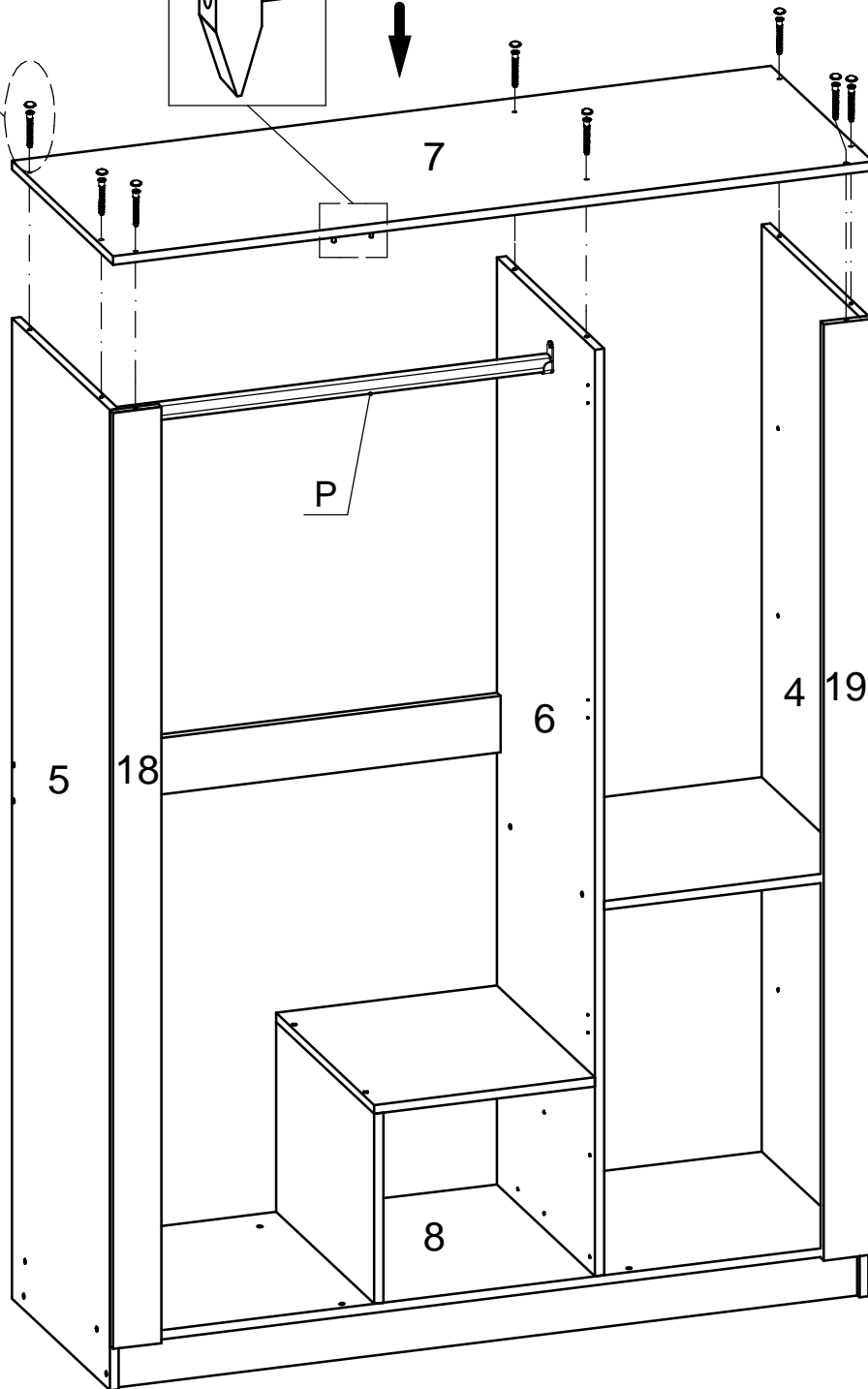
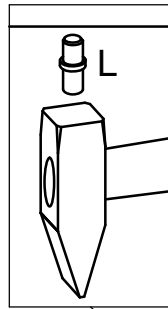
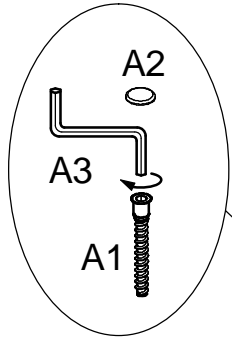
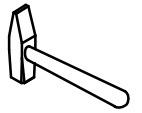

9



C x 5



D3 x 5

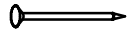

F x 194



N x 8

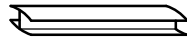

O1 x 1

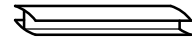

O2 x 1

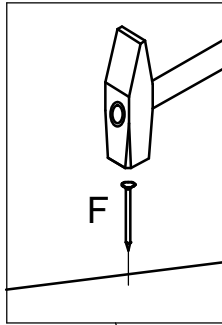
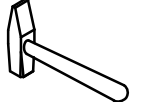
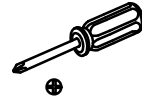

⚠ XX=YY≅90°

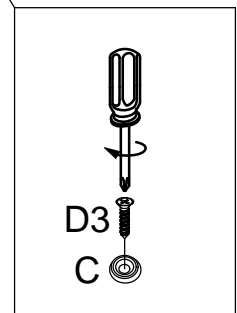
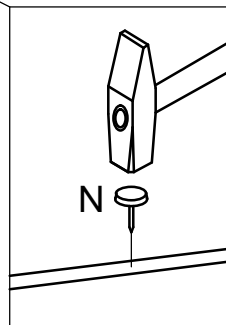
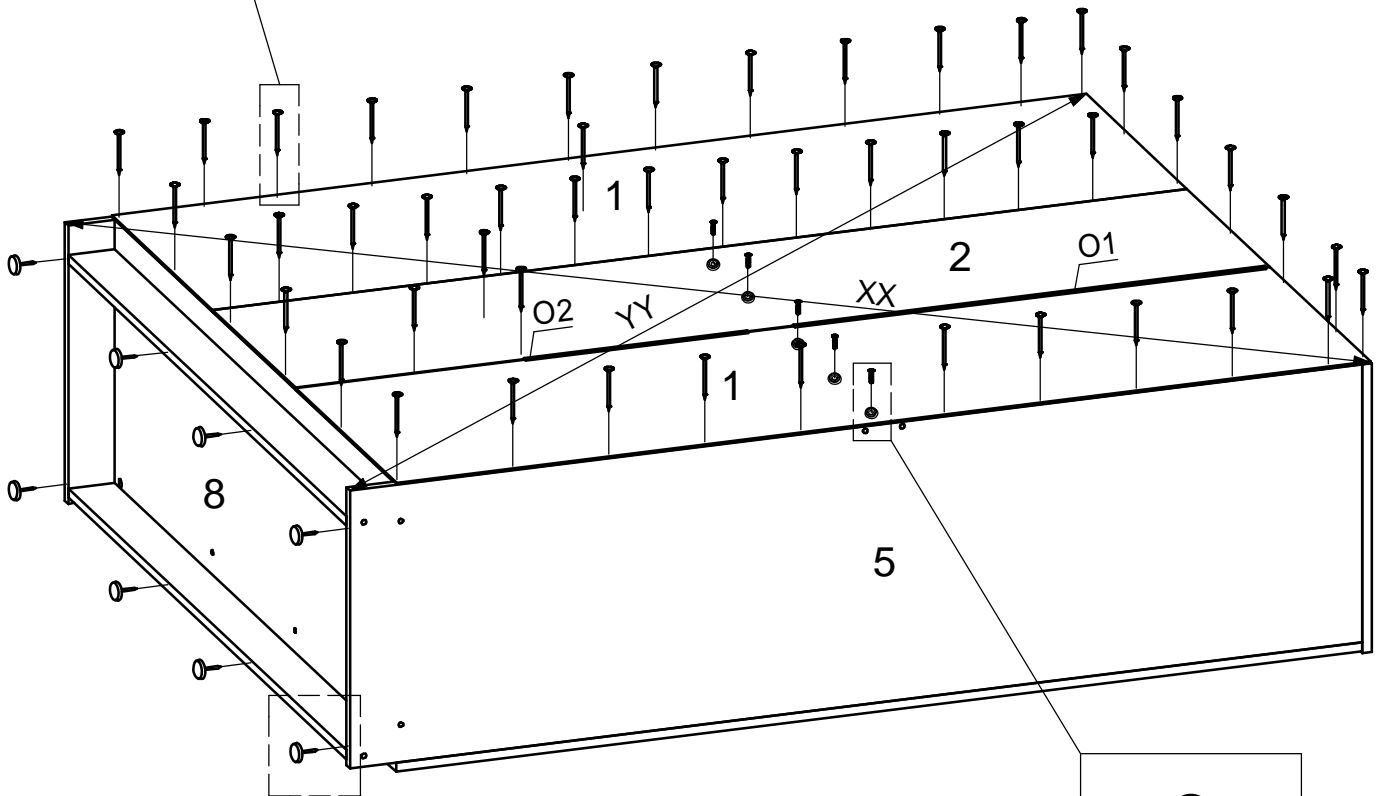

10

- D1 x 12
- D2 x 24
- D4 x 6
- H x 3
- M1.2 x 6
- M2.1 x 3
- M2.2 x 3

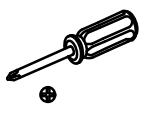
- K1 x 2
  - K2 x 2
- 

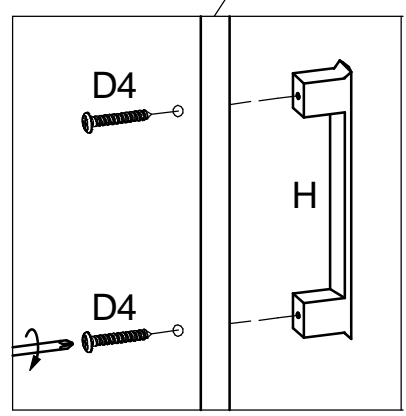
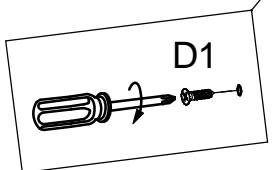
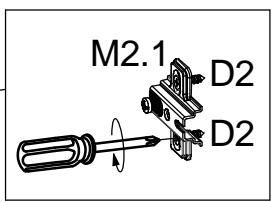
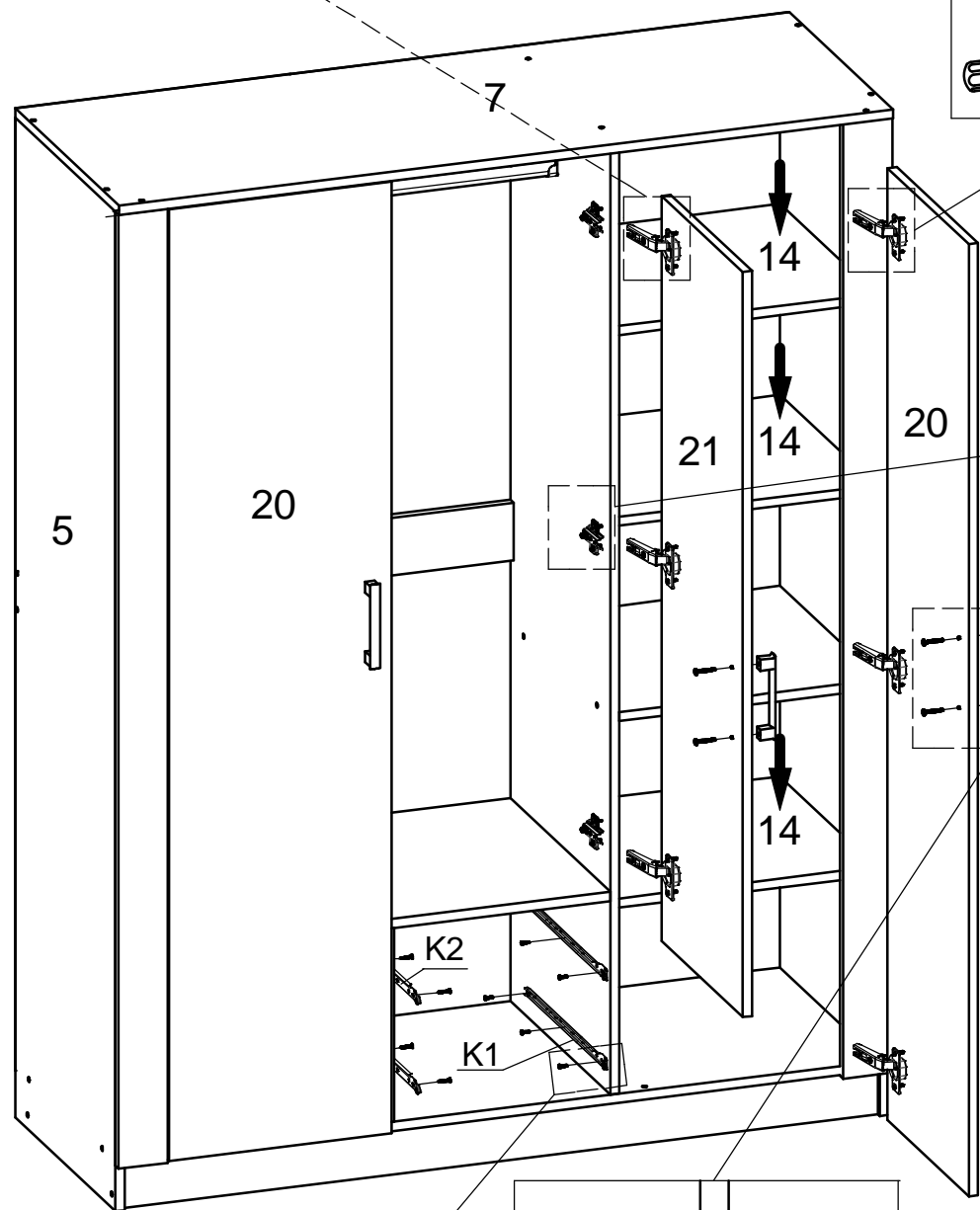
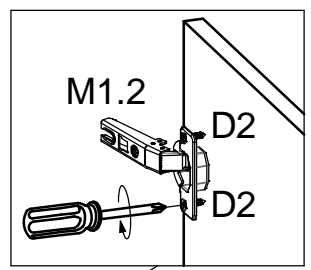
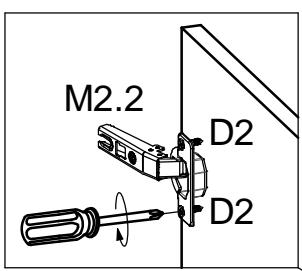

11

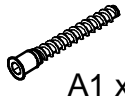

A1 x 8



A2 x 8



A3 x 1



B1 x 4

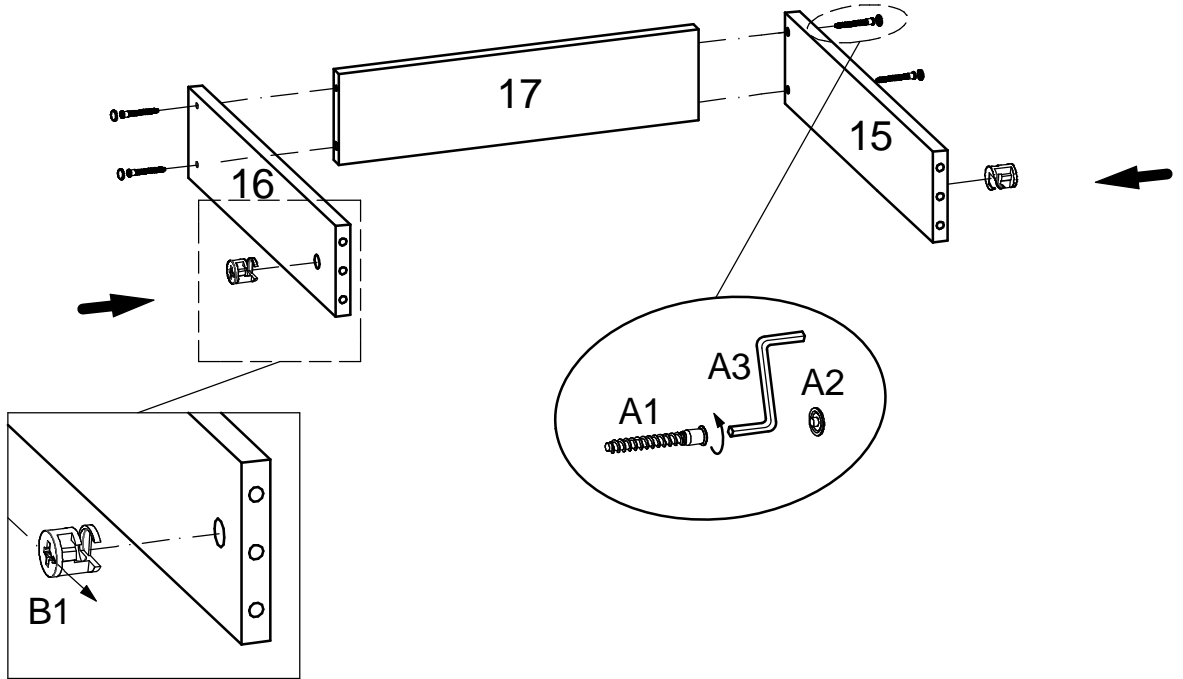

x 2

12



B2 x 4



B3 x 4



D4 x 4



G x 8

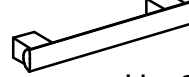

H x 2

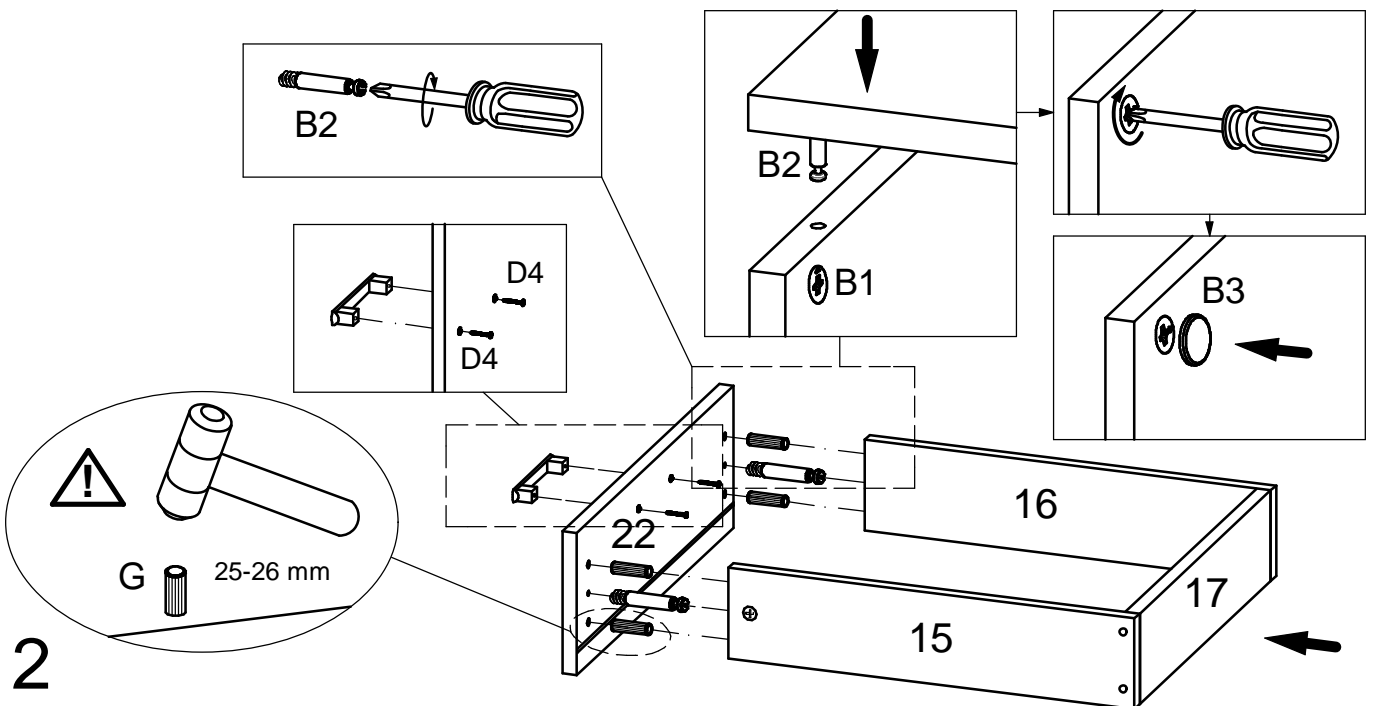
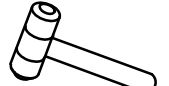
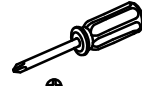

x 2



13

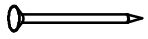

F x 44

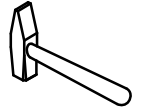

⚠ XX=YY≅90°

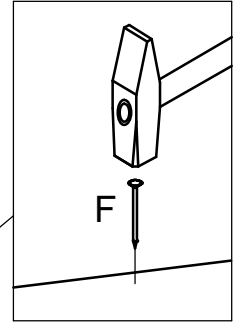
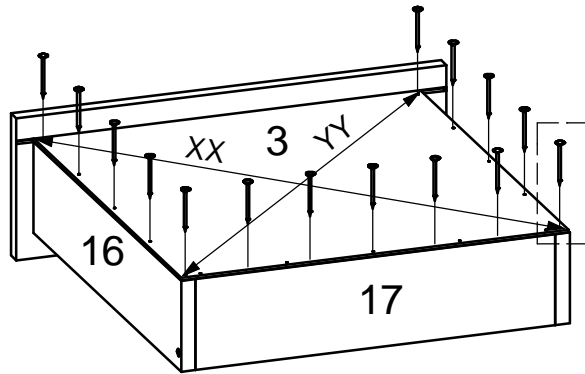

x 2

14



D2 x 12

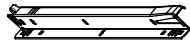

K3x2

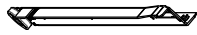

K4x2

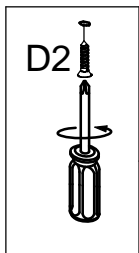
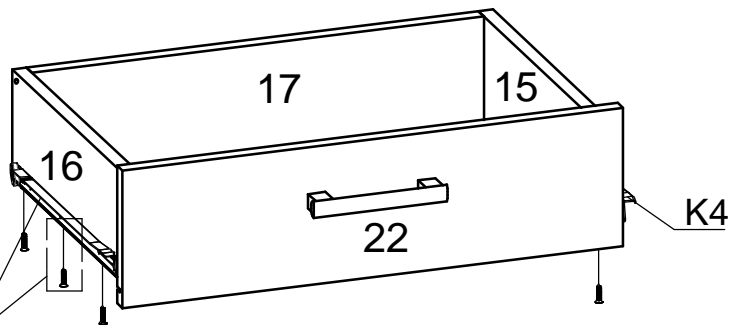
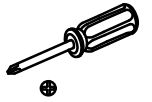

x 2

15

